Why Did the US (Mostly) Go With LMP? Benefits of Flow-Based Allocation

Benjamin F. Hobbs

EPRG, University of Cambridge, UK
DoGEE, Johns Hopkins University, USA
Market Surveillance Committee, California ISO, USA

Karsten Neuhoff

Climate Policy Initiative,
German Institute for Economic Research (DIW Berlin)

“The Role of Power Market Design or the Achievement of the 20% Renewable Target”
Workshop, 10 June 2010, Brussels

Making networks fit for renewables ...

www.eprg.group.cam.ac.uk

Overview



1. Definition of LMP-based markets
2. Benefits of LMP
 - Categories
 - Modeling the unit commitment & international redispatch benefits
3. Why the US chose LMP
4. Continuous improvement

Making networks fit for renewables ...

www.eprg.group.cam.ac.uk

1. Market Restructuring *a la Amerique*



- LMP: Settlement price = nodal λ from 'smart auction'
 - Time varying energy + congestion + loss components
 - Calculated:
 - Ex ante (dual variables) or
 - Ex post (best supports dispatch)
 - Most transactions bilateral; λ adds transparency, liquidity
- Also (FERC 'Wholesale Market Platform'):
 - Multi-settlement markets
 - Guarantee min load & start-up costs
 - Local market power mitigation
 - Financial transmission rights
 - 'Residual unit commitment': commit enough to meet forecast load
 - Capacity or 'resource adequacy' markets
 - Possibility of merchant-based transmission

*To Make LMP
System Work*

Making networks fit for renewables ...

www.eprg.group.cam.ac.uk

Overview



1. Definition of LMP-based markets
- 2. Benefits of LMP**
 - Categories
 - Modeling the unit commitment & international redispatch benefits
3. Why the US chose LMP
4. Continuous improvement

Making networks fit for renewables ...

www.eprg.group.cam.ac.uk

2. Short-term benefits of LMP



- Within country dispatch
 - Lower congestion costs
 - Include losses in dispatch
 - Avoid Inc-dec game
 - Income transfers from consumers
- Unit commitment ****
 - Commitment based on full network
- International redispatch ****
 - Increased use of network
 - Avoid over-conservative definition of NTC
 - Avoid inefficiencies of separate allocation of T & gen
 - Increase market size, reduce local market power
- Demand response to local conditions
- Incentives for operation of network (FACTS devices)
- Increase security of network
 - Feasible day-ahead schedules

**\$170M/yr benefits
from PJM's westward
expansion**

Mansur, E., & White, M., "Market Organization and Market Efficiency in Electricity Markets," Yale School of Management Working Paper, June 2009.

Making networks fit for renewables ...

www.eprg.group.cam.ac.uk

Long-run benefits from LMP



- Incent appropriate siting of gen, load
- Information for T investment
- Reduced need for T investment

Making networks fit for renewables ...

www.eprg.group.cam.ac.uk

Overview



1. Definition of LMP-based markets
2. Benefits of LMP
 - Categories
 - **Modeling the unit commitment & international redispatch benefits**
3. Why the US chose LMP
4. Continuous improvement

Making networks fit for renewables ...

www.eprg.group.cam.ac.uk

Modelling the Unit Commitment & International Redispatch Benefits of LMP

Harry van der Weijde & Ben Hobbs, EPRG



- 3 models of commitment & dispatch costs
 - **LMP**
 - commit s.t. full network (best!)
 - **NTC-IRD**
 - commit s.t. NTC, international redispatch
 - **NTC-NoIRD**
 - commit s.t. NTC, adhere to day-ahead intl MW
 - Quantified for two NTC cases:
 - Optimal NTC (chosen to MIN C)
 - Arbitrary (fixed) NTC
 - Sensitivity to generator sizes, load characteristics
-

Making networks fit for renewables ...

www.eprg.group.cam.ac.uk

Model LMP

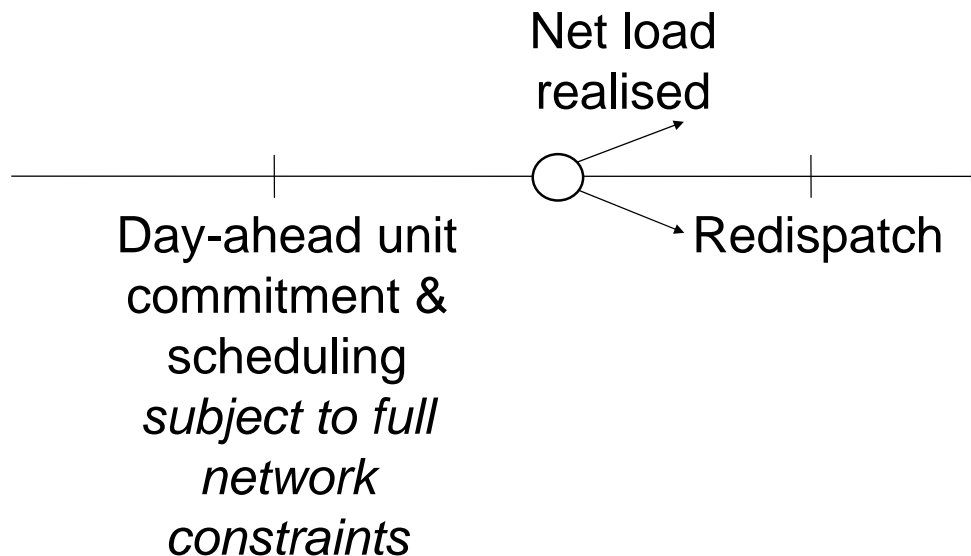

Making networks fit for renewables ...

www.eprg.group.cam.ac.uk

Model NTC-IRD

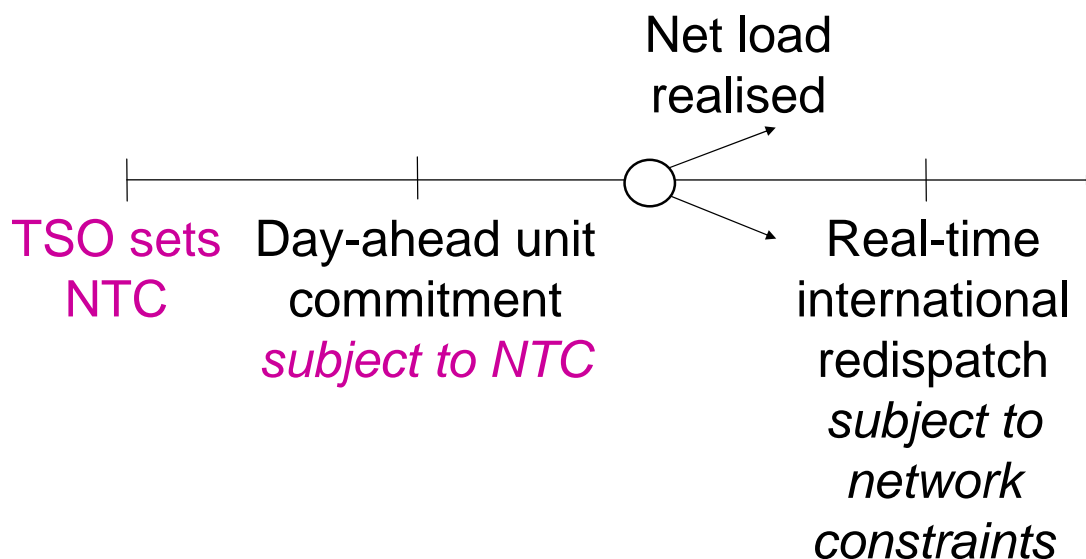

Making networks fit for renewables ...

www.eprg.group.cam.ac.uk

Model NTC-NoIRD

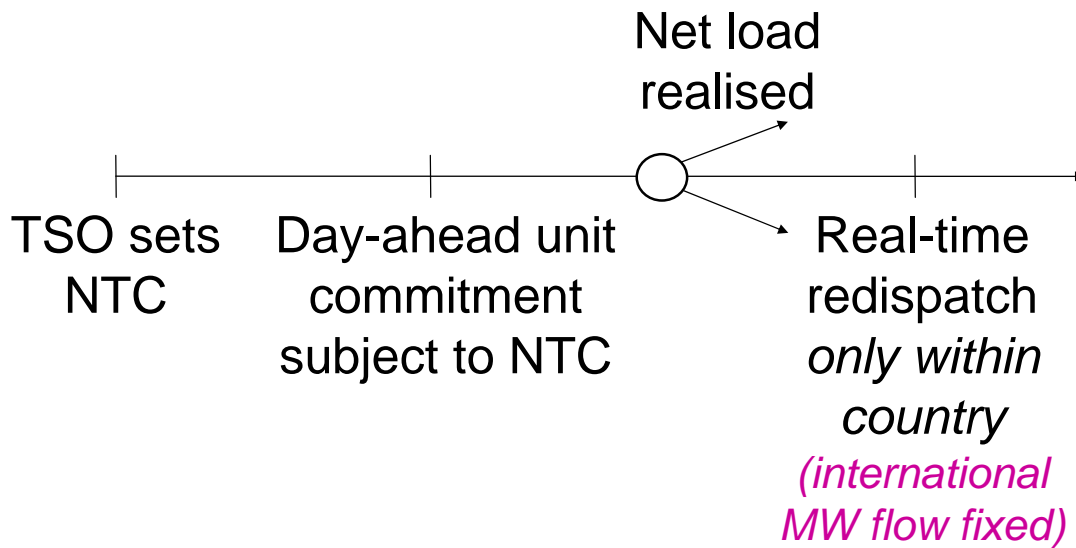

Making networks fit for renewables ...

www.eprg.group.cam.ac.uk

Network

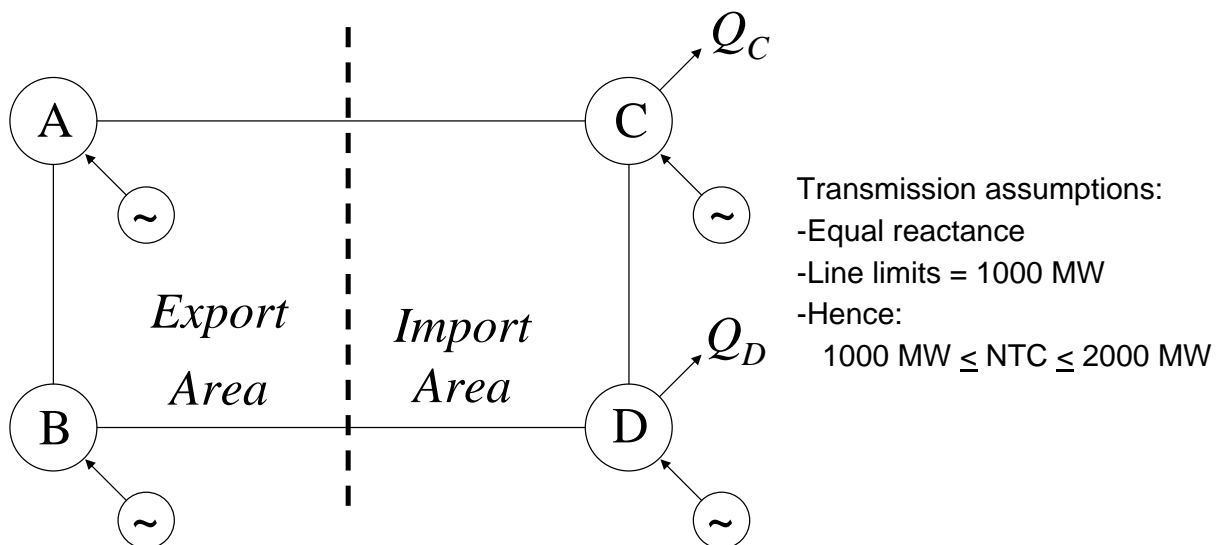

Making networks fit for renewables ...

www.eprg.group.cam.ac.uk

Results – Base Case

Note: LMP cost = \$102,000/hr

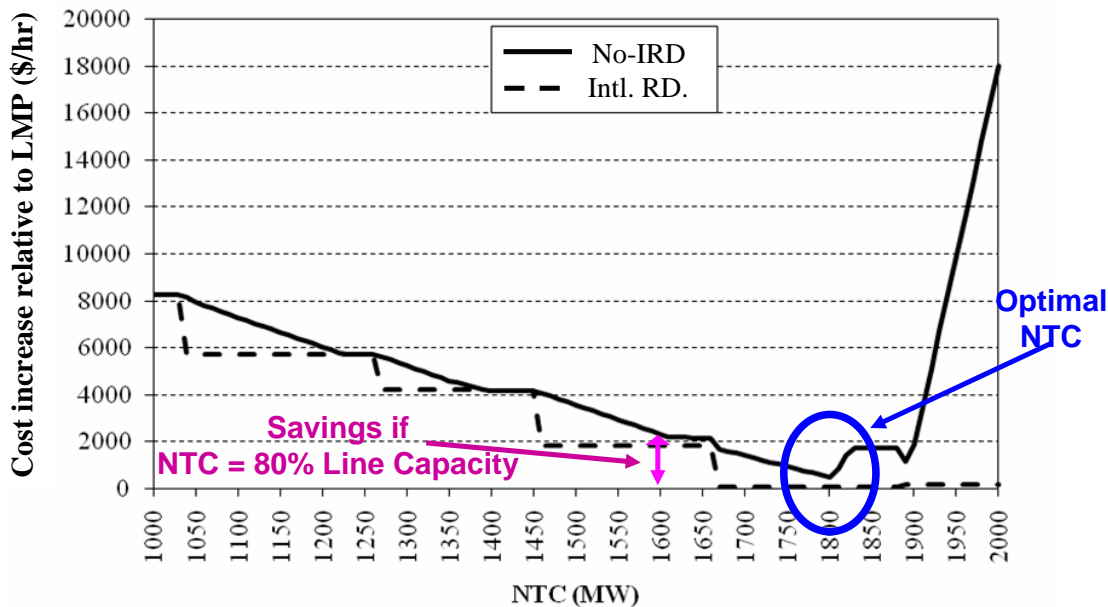

Making networks fit for renewables ...

www.eprg.group.cam.ac.uk

Conclusions



- Unit commitment & redispatch benefits of LMP
 - ~ 0.1-5% of production costs
- But depends on exact load & gen parameters!
 - If optimize NTC:
 - 0-1.7% with intl real-time redispatch
 - 0-2.7% without " " " "
 - If set NTC = 80% of line capacity:
 - 0-5.3% with intl real-time redispatch
 - 0-9.5% without " " " "
- Cf. other studies
 - 0.1% Unit commitment benefits in EU (R. Barth et al., Load-Flow Based Market Coupling with Large Scale Wind Power in Europe. 8th Workshop on Large-Scale Integration of Wind Power in Power Systems, 2009)
 - 0.38 €/MWh Intl. redispatch benefits in F-Be-NL-G example (Oggioni & Smeers, Degrees of Coordination in Market Coupling and Counter-Trading, UCL, 2009)

Making networks fit for renewables ...

www.eprg.group.cam.ac.uk

Work in Progress...

Model Comparison: Renewables Network Integration, Benefits of Flow-Based vs. NTC-Based Allocation



DIW / CPI Berlin

Ecofys

University of Duisburg-Essen

TU Dresden

Universidad Pontificia Comillas

University of Durham

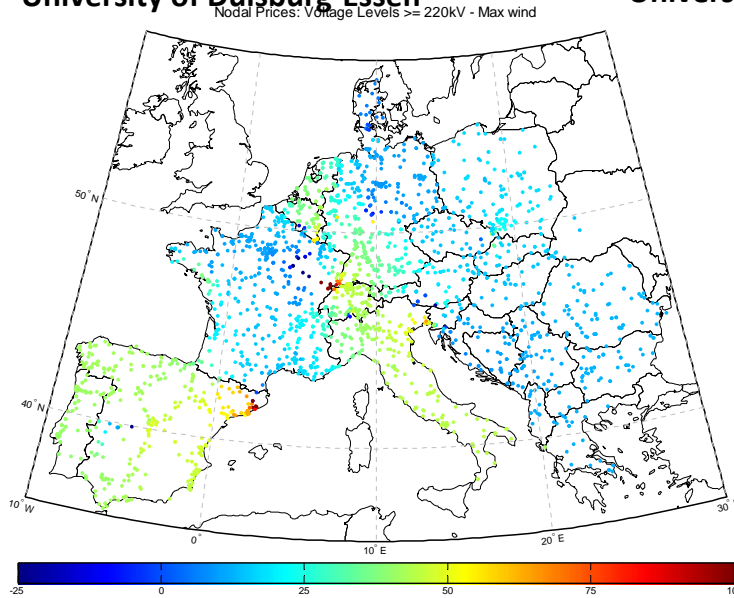

Maxwind

Ecofys

Overview



1. Definition of LMP-based markets
2. Benefits of LMP
 - Categories
 - Modeling the unit commitment & international redispatch benefits
- 3. Why the US chose LMP**
4. Continuous improvement

Making networks fit for renewables ...

www.eprg.group.cam.ac.uk

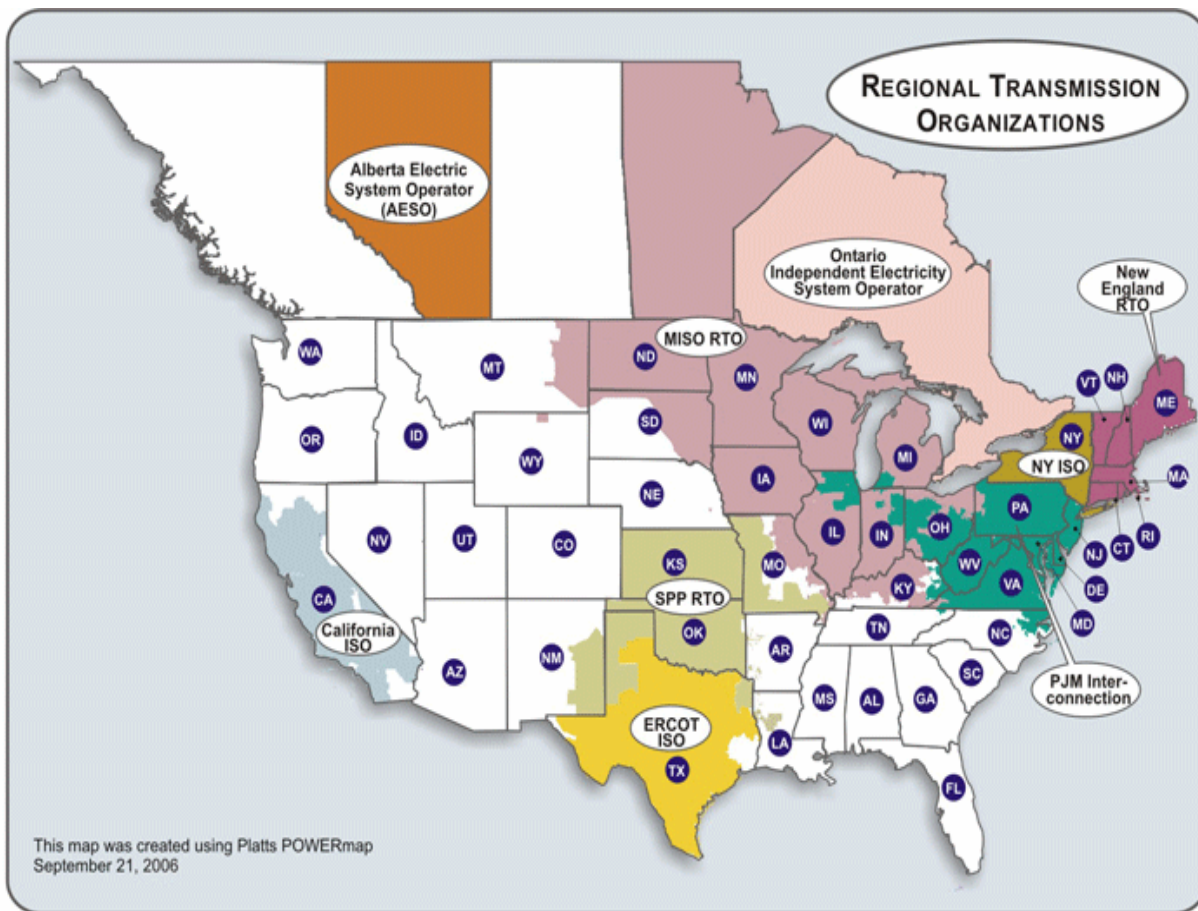

Answer:
***“Zonal” Pricing Failed:
 Learning the Hard Way***



- ***California 2004***
- ***PJM 1997***
- ***New England 1998***

***Better to recognize spatial & intemporal
 constraints by pricing them
 than to make believe they don't exist***

Making networks fit for renewables ...

www.eprg.group.cam.ac.uk

The “DEC” Game in Zonal Markets



- **Clear zonal market day ahead (DA):**
 - One supply curve from all gen bids
 - Clear against zonal load
 - Accepted bids paid DA price
- **“Intrazonal congestion” arises in real-time — & must be eliminated**
 - “INC” needed gen that wasn’t taken DA
 - Pay them > DA price
 - “DEC” unneeded gen that can’t be used
 - Allow generator to pay back < DA price

Making networks fit for renewables ...

www.eprg.group.cam.ac.uk

Problems arising from “DEC” Games



1: Congestion worsens

- Gen you want won’t enter DA
- But gen you don’t want will!
- E.g., PJM 1997

2: DEC game is a money machine

- Gen pocket generators bid cheaply, knowing they can buy back at lower price
 - E.g., $P_{DA} = \$70$, $P_{DEC} = \$30$
 - Make \$40 for doing nothing
- E.g., California 2004

Making networks fit for renewables ...

www.eprg.group.cam.ac.uk

Problems arising from “DEC” Games



3: Short Run Inefficiencies

- If DEC’ed gen started up & then shut down
- If INC’ed gen needed at short notice

4: Long run siting inefficiencies

- Complex rules required to correct perverse incentives
- E.g., New England 1998, UK late 1990s



Making networks fit for renewables

www.eprg.group.cam.ac.uk

Example 1: Cost of DEC Game in California



- Three zones in 1995 market design
- Cost of **Interzonal-Congestion Management**:
 - E.g., \$56M (2004)

2004 Congestion Revenue
2003 Congestion Revenue

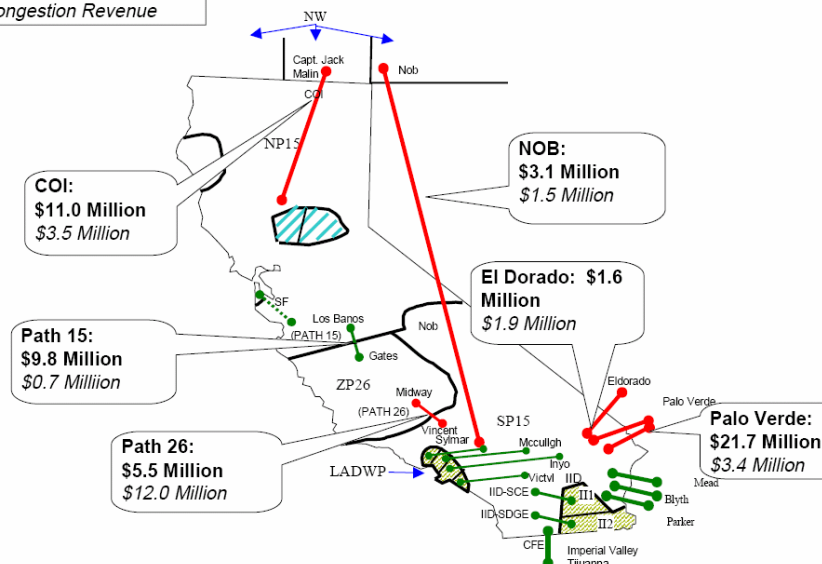

www.eprg.group.cam.ac.uk

Intrazonal Congestion in California (Real-Time Only)



- **\$426M (2004)**
- **Mostly transmission in load pockets**
- **Managed by:**
 - Dispatching “Reliability Must Run” and “minimum load” units
 - INC’s and DEC’s
 - Mean INC price = \$67.33/MWh
 - Mean DEC price = \$39.20/MWh

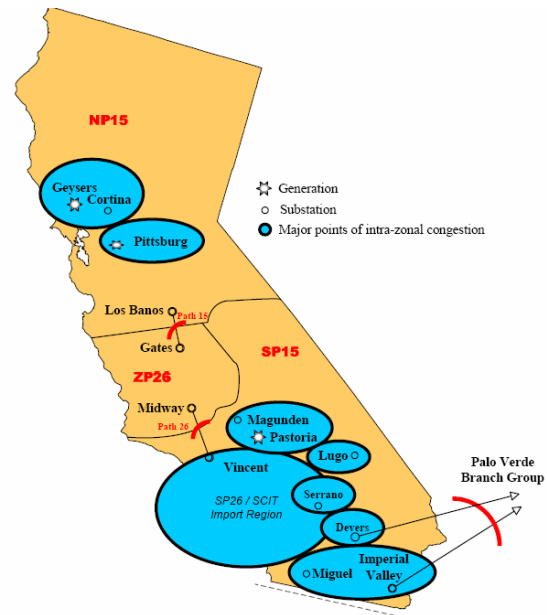

Making networks fit for renewables ...

www.eprg.group.cam.ac.uk

Miguel Substation Congestion



- **1070 MW new gen in Mexico**
 - In SoCal zone
- **Miguel substation congestion limits imports to SoCal**
 - So INC San Diego units
 - DEC Mexican or Palo Verde imports
- **Mexican generation submit very low DEC bids**
 - In anticipation, CAISO Amendment 50 (March 2003) mitigated DEC bids
- **Nonetheless, until Miguel upgraded (2005), congestion management costs ~ \$3-\$4M/month even when mitigated**
 - Value to Mex gen: ~\$5/MW/hr

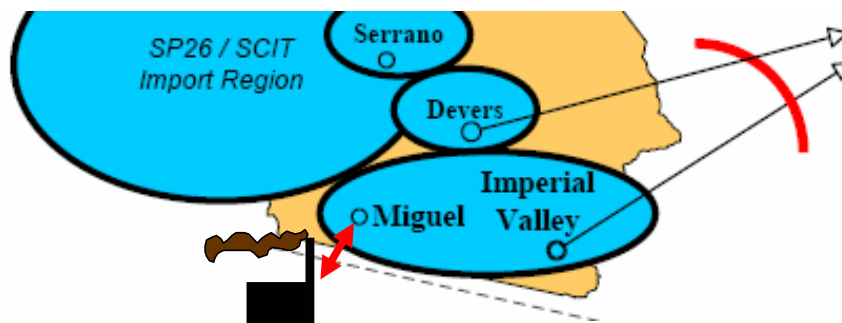

Making networks fit for renewables ...

www.eprg.group.cam.ac.uk

Example 2: PJM Zonal Collapse



- **New 1997 PJM market: zonal DA prices**
 - Congestion to be cleared by RT “INC’s” and “DEC’s”
- **Generators had two options:**
 - Bid into zonal market
 - Bilaterals (sign contract with load, submit fixed schedule)
 - ⇒ **HUGE number of infeasible bilaterals with cheap western gen**
 - PJM emergency restrictions June 1997
- **PJM requested FERC permission for LMP, operational in April 1998**
(Source: W. Hogan, *Restructuring the Electricity Market: Institutions for Network Systems*, April 1999)



Making networks fit for renewables ...

www.eprg.group.cam.ac.uk

Example 3: Perverse Siting Incentives in New England



- **Before restructuring, 1 zonal price**
- **After market opened in late 1990s, ~30 GW new plant announced (doubled capacity)**
 - To correct perverse siting incentives, NEPOOL proposed complex rules
 - extensive studies of system impacts
 - expensive investments in the transmission system.
 - Rules delayed & increased entry costs, protecting existing gen from competition
- **1998, FERC struck down rules as discriminatory and anticompetitive responses to defective congestion management**
 - ISO-NE submitted a LMP proposal in 1999 which was accepted

(See W. Hogan, *ibid.*)

Making networks fit for renewables ...

www.eprg.group.cam.ac.uk

Overview



1. Definition of LMP-based markets
2. Benefits of LMP
 - Categories
 - Modeling the unit commitment & international redispatch benefits
3. Why the US chose LMP
4. **Continuous improvement**

Making networks fit for renewables ...

www.eprg.group.cam.ac.uk

4. Implementing LMP: Ongoing Improvement



- **Basic principles of 'Wholesale Market Platform' work well**
 - *Price all constraints*
 - *Facilitate trade between markets*
 - *Forward contracting*
- **Stakeholders want it to work even better**
 - *24 hrs → several days*
 - *Better security: zonal operating reserves, contingencies*
 - *AC load flow*
 - *Deal with seams barriers between LMP markets*
 - *More temporal variation to reward flexible investment*
 - *Scarcity pricing and 'resource adequacy' to incent investment at right time & place*
 - *Minimize distortion from exclusion of constraints, operator decisions*

Making networks fit for renewables ...

www.eprg.group.cam.ac.uk

Conclusion

You don't always get it right the first time.

Now you have experience-- try FERC's WMP!

NO, WE DIDN'T NIKE OURSELVES BACK INTO THE STONE-AGE. WE DEREGULATED OUR ELECTRIC UTILITIES...



Thanks to Dick O'Neill, FERC

Readings on LMP



General:

- R. Baldick, U. Helman, B.F. Hobbs, and R.P. O'Neill, "Design of Efficient Generation Markets," *Proceedings of the IEEE*, 93(11), Nov. 2005, 1998-2012.
- R.P. O'Neill, U. Helman, and B.F. Hobbs, "The Design of U.S. Wholesale Energy and Ancillary Service Auction markets: Theory and Practice," Ch. 5, in F.P. Sioshansi, *Competitive Electricity Markets: Design, Implementation, Performance*, Elsevier, 2008.
- R.P. O'Neill, U. Helman, B.F. Hobbs, and R. Baldick, "Independent system operators in the United States: History, lessons learned, and prospects," Ch. 14, in F. Sioshansi and W. Pfaffenberger, *Electricity Market Reform: An International Perspective*, Elsevier, 2006, 479-528.

Presentation References:

- R. Barth et al., Load-Flow Based Market Coupling with Large Scale Wind Power in Europe. 8th Workshop on Large-Scale Integration of Wind Power in Power Systems, Duisberg-Essen University, 2009
- W. Hogan, Restructuring the Electricity Market: Institutions for Network Systems, April 1999 (available Harvard Electricity Policy Group HEPG Website)
- G. Oggioni & Y. Smeers, Degrees of Coordination in Market Coupling and Counter-Trading, Universite' Catholique Louvain-la-Neuve, 2009

ISO LMP Training Materials

CAISO MRTU training

- Locational Marginal Pricing (LMP) 101 Course Overview of Locational Marginal Pricing
- <http://www.caiso.com/1824/18249c7b59690.html>
- <http://www.caiso.com/20a6/20a690af67c80.html> slides only
- New England
- http://www.iso-ne.com/nwssis/grid_mkts/how_mkts_wrk/lmp/index.html
- PJM Training Curriculum
- http://www.pjm.com/sitecore/content/Globals/Training/Courses/ol-lmp-101.aspx?sc_lang=en
- <http://www.pjm.com/~media/training/core-curriculum/ip-lmp-101/lmp-101-training.ashx>
- <http://www.pjm.com/~media/training/core-curriculum/ip-gen-101/20050713-gen-101-lmp-overview.ashx>
- https://admin.acrobat.com/_a16103949/p20016248/ with audio accompaniment

Making networks fit for renewables ...

www.eprg.group.cam.ac.uk